

LED Vanity Light

VL16024
INSTALLATION SHEET

START FROM HERE

- Make sure **POWER** is **COMPLETELY OFF** at the fuse box
- Have your fixture installed by a qualified licensed electrician
- Prepare everything in a clear area
- Wear gloves at all time during this installation
- Read instructions carefully before you start assembly
- Keep this installation sheet for future reference

Please Note:

- All Kuzco LED fixtures come with pre-wired LED module(s).
- Unless instructed to do so, please do not touch any part of the LED module(s) as any unnecessary contact with the module could cause permanent damage.
- For dimming, an ELV (Electronic Low Voltage) type of dimmer is required.

Technical Support: 1-855-855-8926

- 1.** Remove the fixture from its original packaging. Remove the mounting plate **(1c)** from within the canopy **(2b)** by unthreading two set screws **(2a)**. Attach the mounting plate **(1c)** to the electrical junction box **(1a)**, using screws **(1d)** provided in the hardware package.
- 2.** Attach the canopy to the mounting plate. First connect all wires correctly G ground to ground, N neutral wire (white to white), L live wire (black to black) with provided marettes **(1b)** from the hardware package. Now place the canopy **(2b)** onto the mounting plate **(1c)**. As you move the canopy, align the top holes to the holes on the mounting plate **(1c)**. Secure the canopy by threading in the the two set screws **(2a)** with the allen key provided.
- 3.** You have now completed the installation of your fixture, enjoy.

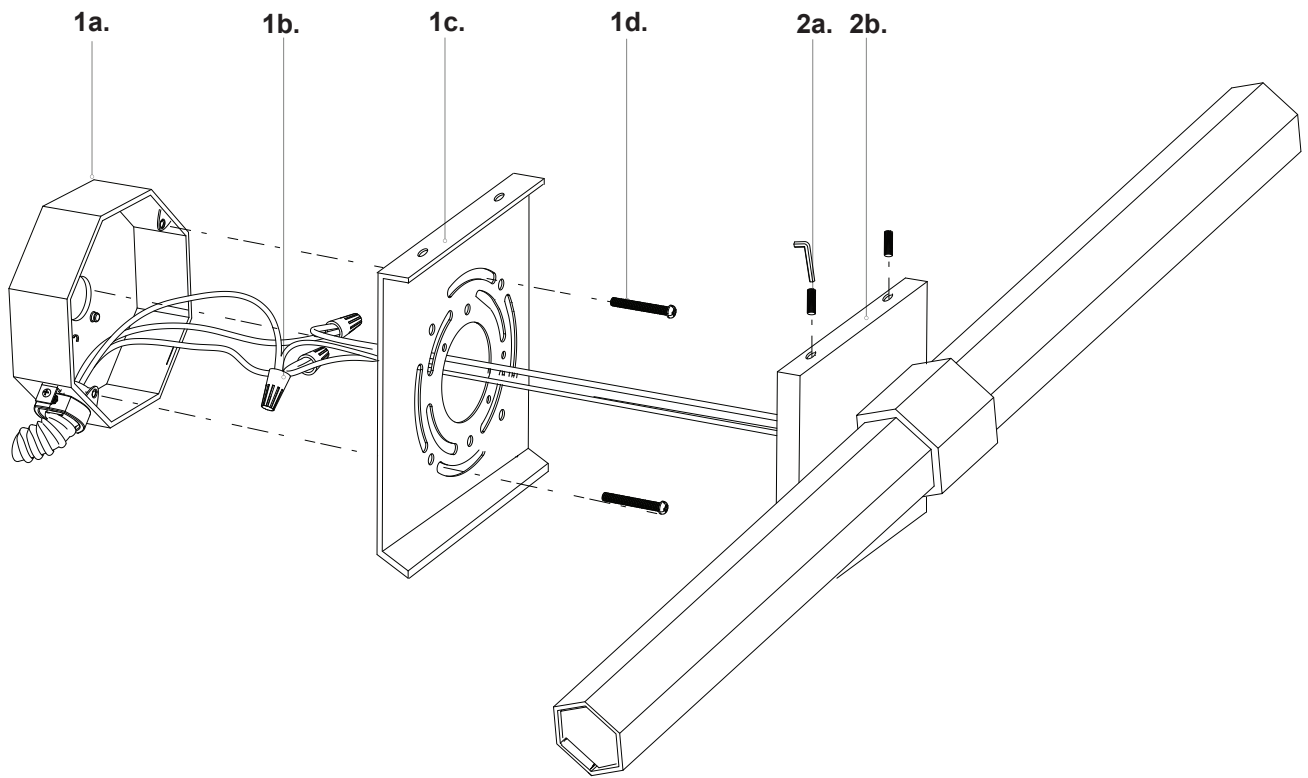

KUZCO

19054 28th Avenue Surrey, BC Canada V3Z 6M3
T: 604 538 7162 TF: 1-855 85 KUZCO F: 604 538 7196
W: kuzcolighting.com
20181127